

### 1 Installation

#### - Recommendations :

- Keep a minimum distance of 0.2 m (8 inches) between two 3.5 DC EHz motors.
- Keep a minimum distance of 0.3 m (12 inches) between 3.5 DC EHz motors and Hz transmitters.
- Radio appliances operating on the same frequency (433.42 Mhz) may interfere and reduce system performance (Examples: hi-fi radio headphones, wireless security components, etc...).

#### - Preparing the tube:

				A (mm)	ØB (mm)	C (mm)	D (mm)	L1 (mm)	L2 (mm)
13.5 DC EHz				433	4.2	8	5.5	457	470
12 VDC	3Nm - 6Nm - 10Nm			37					

#### - Assembly :

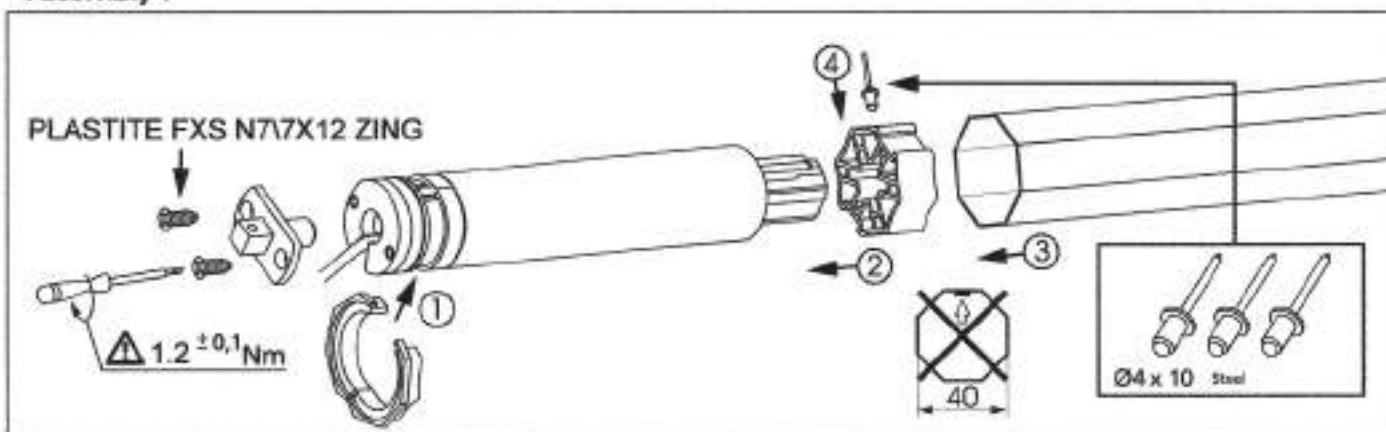

### 2 Compatible transmitters



- 1 : Hz wall transmitter      3 : Hz timer  
2 : 1 / 5 channels Hz transmitters      4 : DecoFlex

#### Transmitters range :

20 m through 2 concrete walls .

- Do not position the transmitter near metal surface or structure in order to avoid range loss.

Location of the "PROG" key on Hz transmitters:

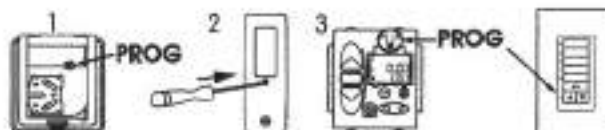

### 3 End limits adjustment

1 - During the operations in this section (3), only power one motor at a time.

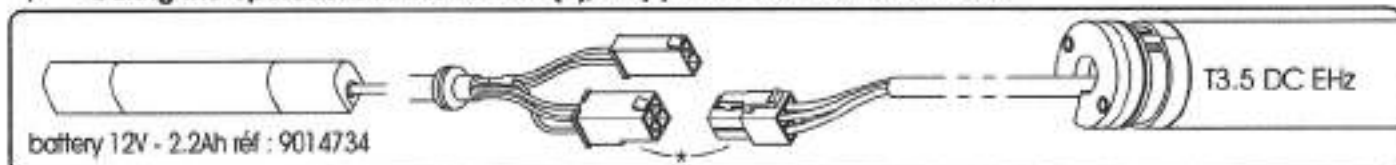

#### 3.1

a- Connect the motor to the power supply.

\* For any further information regarding the technical characteristics of power supply please consult the technical booklet SIMU® ref.:5059076

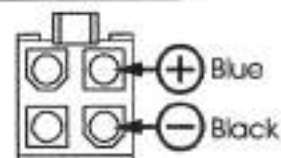

b- Press simultaneously on the UP and DOWN buttons of a Hz transmitter. The motor will jog (turn 0.5 seconds in one direction and then in the other).

**This transmitter now commands the motor in constant pressure mode.**

Go to section 3.2

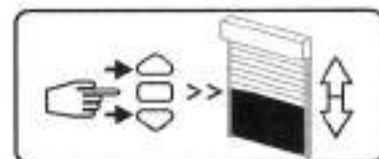

#### 3.2 - Test and change the direction of rotation

Press on the UP button of the transmitter:

a- if the motor turns in the UP direction, go to step 3.3

b- If the motor runs in the DOWN direction, reverse the direction of rotation by pressing the STOP button for at least 3 seconds until the motor jogs. Confirm the direction of rotation is now correct.

Go to section 3.3.

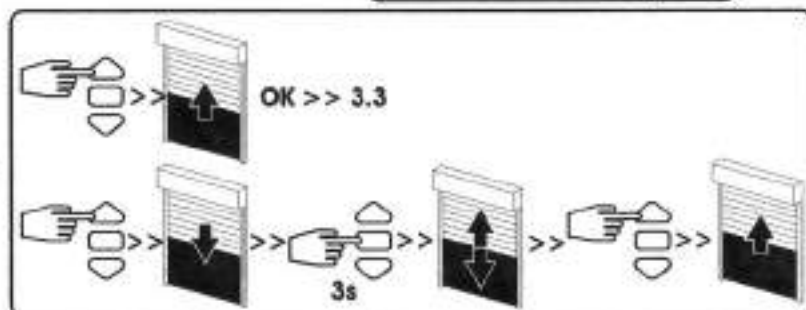

#### 3.3 - End limits adjustment

⚠ The end limits of the T3.5 DC EHz can be set in 4 different ways. The motor can auto set a limit if there is a physical stop in a given direction. If not, the limit can be set from the transmitter.

(A) Automatic both limits

(B) Automatic down limit

(C) Automatic up limit

(D) User set both limits

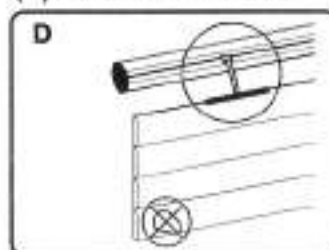
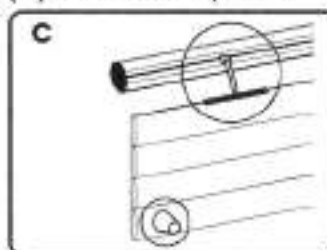

##### A - Automatic both limits

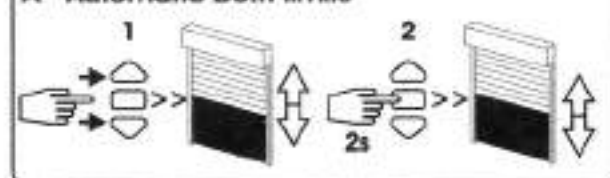

\* Section 3.1 and 3.2 must be complete

1- Simultaneously press the UP and DOWN buttons of the Hz transmitter until the motor jogs

2- Press the "stop" button for 2 s until the motor jogs.

The operation is complete. Go to section 4.

##### B - Automatic down limit, user set the top limit

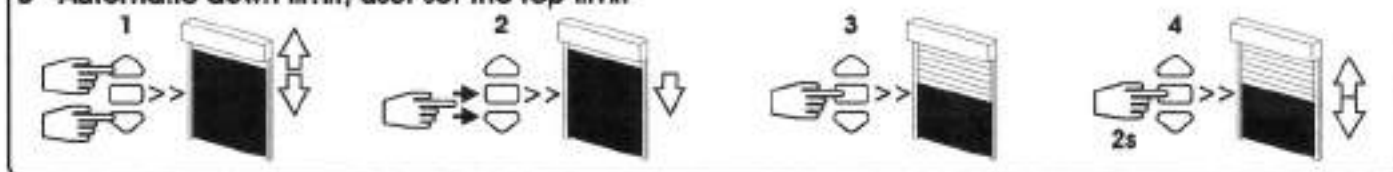

\* Section 3.1 and 3.2 must be complete.

1- Position the motor on the desired UP end limit by using the UP or DOWN buttons.

2- To memorize the UP limit position, press simultaneously the STOP and DOWN buttons. The motor will run automatically in the DOWN direction.

3- Stop the motor by pressing the STOP button.

4- Press the STOP button for 2 seconds to validate the setting. The motor will jog to confirm.

The operation is completed. Go to section 4.

### C - Automatic up limit, user set the down limit



\* Section 3.1 and 3.2 must be complete.

- 1- Position the motor on the desired DOWN end limit by using the UP or DOWN buttons.
- 2- To memorize the DOWN limit position, press simultaneously the STOP and UP buttons. The motor will run automatically in the UP direction.
- 3- Stop the motor by pressing the STOP button.
- 4- Press the STOP button for 2 seconds to validate the setting. The motor will jog to confirm the operation is complete. Go to section 4.

### D- User set both limits



\* Section 3.1 and 3.2 must be complete.

- 1- Position the motor on the desired DOWN end limit by using the DOWN or UP buttons
- 2- To memorize the DOWN limit position, press simultaneously the STOP and UP buttons. The motor will run automatically in the UP direction.
- 3- When the motor arrives on the desired UP End limit, press the STOP button
- 4- If necessary adjust the position with the UP or DOWN buttons.
- 5- To memorize the UP end limit position, press simultaneously the STOP and DOWN buttons. The motor will run automatically in the DOWN direction.
- 6- Press the STOP button for 2 seconds to validate the setting. The motor will jog to confirm the operation is complete. Go to section 4.

## 4 Programming the first transmitter

**⚠ - This operation can only be performed from the transmitter that was used for operation 3.1B, and after the limits have been set as per section 3.3 A, B, C or D**

- Press the transmitter "PROG" programming button for approximately one second. The motor will jog

**Your transmitter is now programmed to control the motor in stable mode. All the functions described in section 6 are active.**

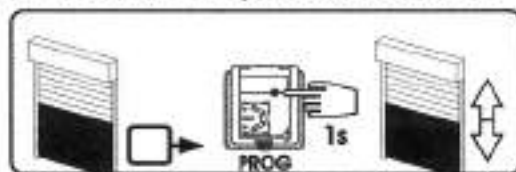

## 5 Adding another transmitter channel (individual, group or main)

### 5.1 - Set the motor to learn mode using the original transmitter:

- Press the "PROG" programming button of the current transmitter for about 3 seconds. The motor will jog

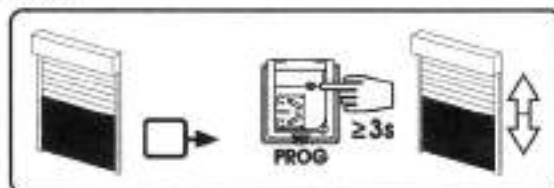

### 5.2 - Add the new transmitter (channel)

- Press the "PROG" programming button of the new transmitter (channel) for about 1 second. The motor will jog.

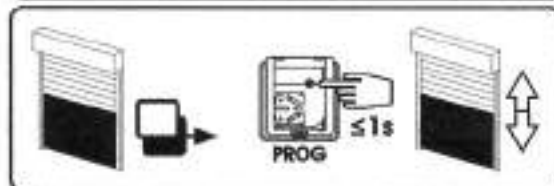

- For **group controls**, repeat operations 5.1 and 5.2 for each motor in the group.
- For **master controls**, repeat operations 5.1 and 5.2 for each motor in the installation.
- To **delete an transmitter** from the memory of a motor, perform operation 5.1 with a programmed transmitter, then perform the operation 5.2 with the transmitter to be deleted.

## 6 T3.5 DC EHz motor operation

6.1 - With a well charged battery, the possible commands are: Up, stop and down. It is also possible to set an intermediate position (see section 7).

6.2 - **Jam detection function:** The motor stops if blocked while trying to open.

6.3 - **Detection of obstructions function:** An obstruction that stops the motor when closing will cause the motor to stop or stop and reverse if in the middle of its travel

6.4 - **Battery protection against excessive discharge:** Before each operation, the motor checks the battery voltage.

**If the voltage is below 11.5V** The motor will pause at the beginning of each up command. The motor will run down only after pressing several times on the "down" button. This is to inform the user the voltage is low.

**If the voltage is below 10V** The motor will not react to any commands.

**In these two cases, the emergency charger can be used to perform a quick battery recharge.**

**Operation of the motor will return to normal only if the battery voltage goes above 12V**

## 7 Recording and using intermediate position

### Recording:

- Position the motor at the desired position.
- Press for 5 seconds on the stop button. The motor will jog.

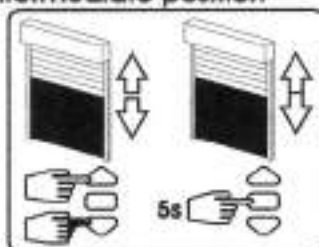

### Using the IP:

When the motor is stopped at any position, press the stop button for 0.5 seconds. The motor will automatically travel to the intermediate position.

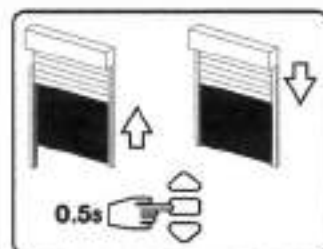

## 8 Re-adjustment of end limits

### 8.1 - Re-adjustment of UP end limits: (B and D user set limit only - section 3.3)

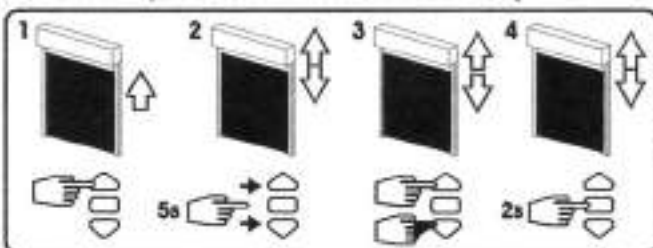

- 1- Run the motor up and let it stop at the top limit.
- 2- Press simultaneously for 5 seconds the UP and DOWN buttons until the motor jogs
- 3- Use the up and down buttons to run the motor to the new limit position.
- 4- Validate the new position by pressing the stop button for 2 seconds until the motor jogs  
The new up limit setting is memorized.

### 8.2 - Re-adjustment of DOWN end limits: (C and D user set limit only -section 3.3)

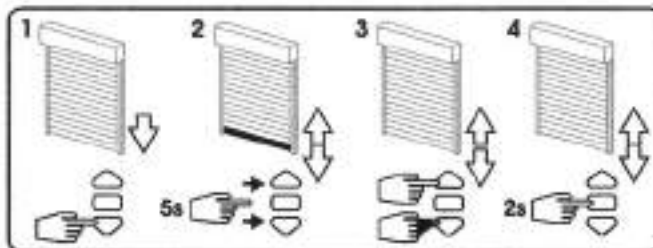

- 1- Run the motor down and let it stop at the bottom limit.
- 2- Press simultaneously for 5 seconds the UP and DOWN buttons until the motor jogs
- 3- Use the up and down buttons to run the motor to the new limit position.
- 4- Validate the new position by pressing the stop button for 2 seconds until the motor jogs  
The new down limit setting is memorized.

⚠ - For auto set limits (the A and B up limit, A and C down limit), the re-adjustment of end limits is automatic every 56 cycles or after a power cut. The motor will retest the limits for the next 3 cycles.

## 9 Return to Factory Mode

9.1 - **Switch off** the power supply to the motor for 8 seconds.

- **Switch on** the power supply to the motor for 8 seconds.

- **Switch off** the power supply to the motor for 8 seconds.

- **Switch the power to the motor back on.** The motor will run for 5 seconds in a random direction and is now in the "reset" mode.

9.2- Validate the "reset" of the selected motor from the programmed transmitter

- Press and hold the "PROG" programming button for over 7 seconds until the motor jogs. The motor is now in factory mode.

Go to section 3 to start programming.

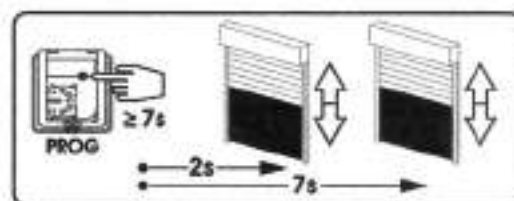

**To use the reset button on the battery to clear old transmitters** press the button for 7 seconds until the motor jogs twice. The old transmitters are cleared but the limits are still programmed. Press the up and down buttons on the new transmitter to wake the motor. Press the programming button on the new transmitter.

**To use the reset button on the battery to reset the motor to factory mode** press the button for 12 seconds until the motor jogs 3 times. The motor is now in factory

